

# ANALEMMAS

on the gnomon  
and  
on the dial plate

armillary dials



equatorial dials



horizontal and vertical dials also  
and vertical decliners  
and polar and meridian



please read: [Declining Shadows \(Declining-Shadows.pdf\)](#) for declination curve insights and methods.

this is: [gnomonDialplateAnalemma.pdf](#), and [Illustrating Time's Shadow](#) chapter 24 goes into these subjects in more detail.

using these: [gnomonDialplateAnalemma.bas](#)

[gnomonDialplateAnalemma.xls](#)  
[gnomonDialplateAnalemma.ods](#)

also see: [illustrating-shadows.xls](#)  
[illustrating-shadows.ods](#)

NOTE: [illustrating-shadows.xls](#) has always had the h-dial analemma support as has the Open Office version as well.

## ANALEMNAS

The analemma is a depiction of the equation of time and the day of the year. Shown on globes as a distorted figure of eight, it is also shown as a wavy graph.

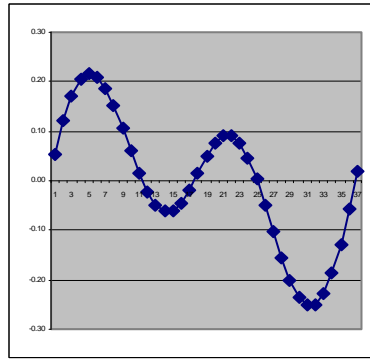
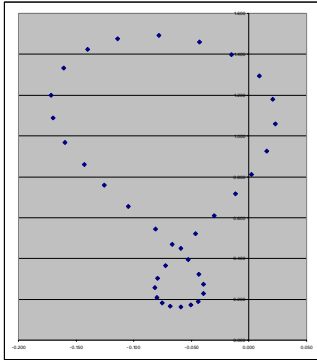

Since the date is less practical for the purpose of trigonometry, the sun's declination is used.

This booklet uses the sun's declination (for a given date), and the equation of time (eot) to derive X and Y values for either the analemma on a dial plate, or on a gnomon.

The analemma on a dial plate has the benefit of being simpler, and as shall be seen, more accurate. However the dial plate gets cluttered, especially when half and quarter hours are added in, as well as calendar curves, and Italian lines.

The benefit of having the analemma on a gnomon's style is that the dial plate is less cluttered. However there are drawbacks.

If the style has a 3d bobbin form of analemma, inaccuracies are introduced. This is because it is either symmetrical or it is not. If it is symmetrical, then for a given solar declination which may have two different eot values, an average is used, and that average generates an error.

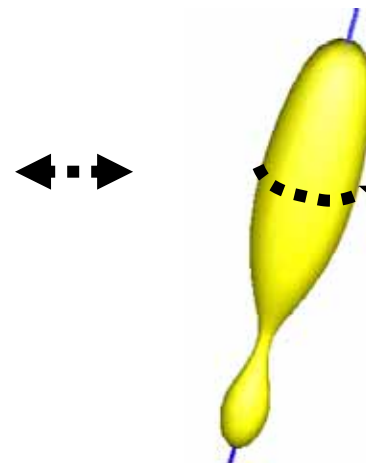
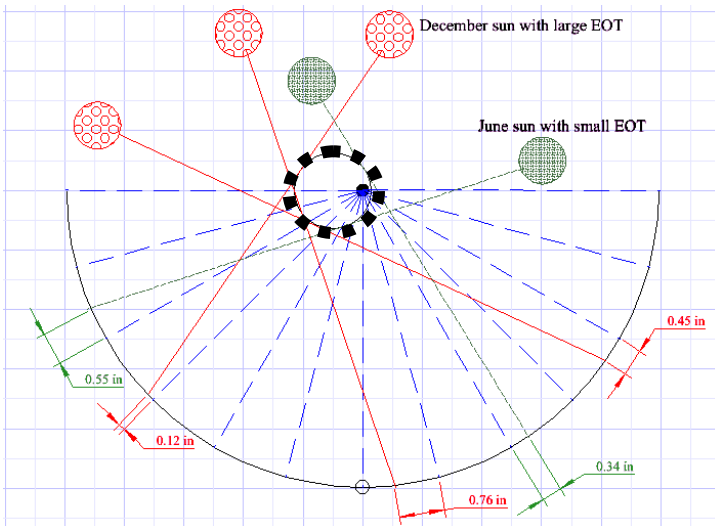

If it is not symmetrical then there are still inaccuracies because the same point on the bobbin gnomon style will displace the shadow on the dial plate differently for different hours on the same day. For example, if you use the bottom of the bobbin gnomon then at 8am the time indicated is late, whereas using the bottom of the gnomon for 4pm, the time indicated is early.

In essence, 3d bobbins must be symmetrical because you must be consistent about the part of the shadow you are using, i.e. the left part, or the right part. So for 3d bobbin gnomons, the bobbin is symmetrical and thus always provides an average of the EOTs for any given declination.

The solution is to have a flat not a 3d gnomon. While this allows an asymmetrical analemma, it also requires that the analemma be rotated to be perpendicular to the sun's rays. The conclusion about analemma depiction on sundials is thus:

An analemma on the dial plate  
is easy to make accurate  
works only for the hours it is associated with  
requires interpretation for other hours  
clutters the dial plate when other furniture is there

A 3d bobbin on the gnomon's style has to be symmetrical  
is thus an average of EOTs for the same solar declination  
is harder to make than an analemma on a dial plate  
is easy to read for any hour

A 2d analemma on the gnomon's style can be asymmetrical  
thus has accurate EOT depiction  
is easier to make than a 3d bobbin  
requires you to rotate it

A table or chart of EOTs  
is easy to use  
requires only one simple addition or subtraction  
does not clutter the dial plate or gnomon  
but requires it to be placed somewhere in easy reach

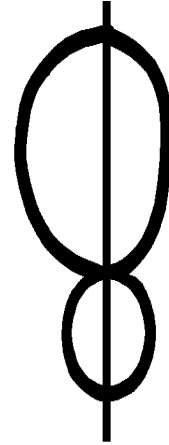

## THEORY OF THE EQUATION OF TIME (EOT)

For the theory, see the web site supplement: [www-equation-of-time.pdf](http://www-equation-of-time.pdf)

However, *Illustrating More Shadows*, or its replacement *ILLUSTRATING TIMES SHADOW* has a simpler description of the EOT. The *Illustrating Shadows* spreadsheets for Excel and Open Office have EOT options, one being the highly accurate astronomical version.

## IMPLEMENTATION

*Illustrating Shadows* provides free Excel and Open Office (a free program) spreadsheets with X and Y values facilitating graph paper depiction of an analemma. This is more accurate than polar coordinates (angle and distance) since the angles are rather small thus errors can easily creep in. Also, DeltaCAD programs provide a pictorial of the analemma, as well as X and Y coordinates.

You choose whether to place an analemma on a dial plate, or use the gnomon's style with a 3d bobbin, or a 2d template, or whether to use a table or graph of EOTs.

NOTE: Always double check the EOT template and make sure the analemma is oriented properly.

## SPECIAL CASE AND AN INTERESTING CONCLUSION

The armillary and equatorial dials are special cases as they use the declination directly, other dials require solar altitude and azimuth except for local noon. There is a benefit to using that one time that is EOT corrected, the plate is less cluttered, has the EOT chart built in, and even if a full plate of analemmas is constructed, except for those blessed hours, you still must interpolate.

This document may be copied freely provided credit is retained. The web site should be checked for updates on a regular basis: [www.illustratingshadows.com](http://www.illustratingshadows.com) 2  
August 31, 2009

## ARMILLARY DIAL ~ analemma on the gnomon style

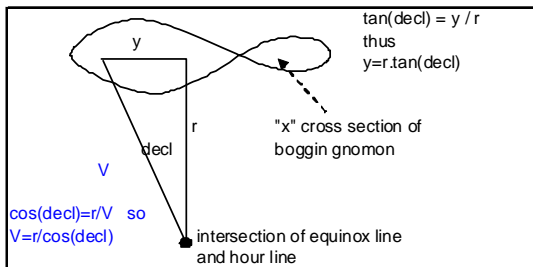
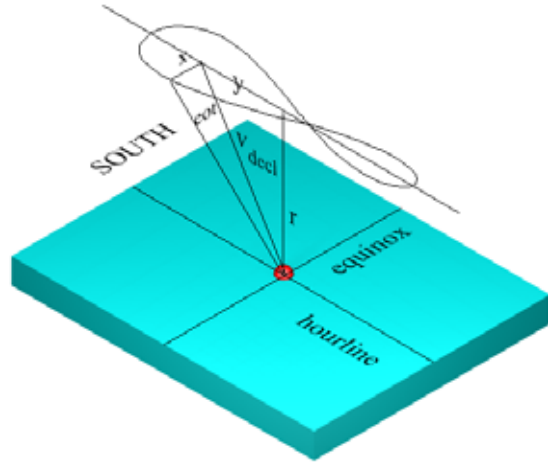
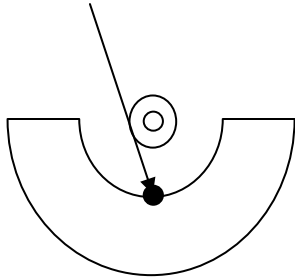

VIEWED SIDWAYS FROM EAST OR WEST

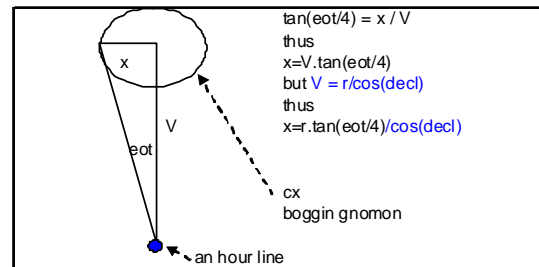

VIEWED FROM THE EQUATOR LOOKING TO THE POLE

The formula for Y (north or south along the style of the gnomon) and Y (east or west parallel to the earth) for an analemma is derived as shown above, and is:-

$$\begin{aligned} eot &= 7.5 * \text{Sin}(\text{RAD}(jd-5))-10.2*\text{Sin}(\text{RAD}(1.93*(jd-80)))+0.5*\text{Sin}(\text{RAD}(1.5*(jd-62))) \\ decl &= 23.45 * \text{Sin}(\text{rad}(0.9678*(jd-80))) \end{aligned}$$

$$\begin{aligned} y &= r * \text{Tan}(\text{rad}(decl)) \\ V &= r / \text{Cos}(\text{rad}(decl)) \\ x &= V * \text{Tan}(\text{rad}(eot/4)) \\ &= r * \text{Tan}(\text{rad}(eot/4) / \text{Cos}(\text{rad}(decl)) \end{aligned}$$

There is an approximation even still, in the above. It assumes the plane of the analemma is perpendicular to the line from the hour line up to the analemma's bobbin center. Of course, instead of a bobbin in 3d, a 2d plate can be used which is rotated to parallel the dial plate surface where the hour line is located.

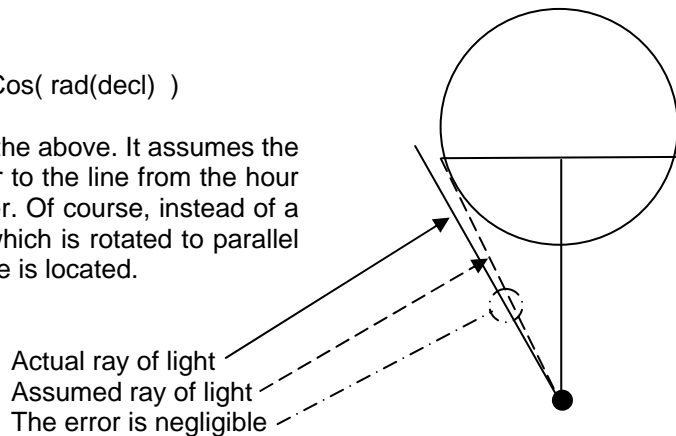

**NOTE:** As discussed earlier, 3d bobbin analemma in essence requires the EOT radius to be the same for a given solar declination, thus you must average the two EOT radii for a declination. A better alternative is a rotatable 2d analemma on the style.

The spreadsheet for this is in the Excel and Open Office and ANALEMMA folders:-

all three folders: gnomonDialplateAnalemma.xls  
gnomonDialplateAnalemma.ods

BOBBIN SHAPE FOR ARMILLARY DIAL – the correct time is read at the equinox line  
radius of bobbin from armillary

3.375 inches

JD	EOT (calculated)	DECL	Y distance along bobbin where sun hits the bobbin and thence the equinox line on the armillary $Y=r.\tan(d)$	X radius of bobbin at the Y distance – $X=r.\tan(eot/4)/\cos(decl)$	INCHES
1	3.393847	-23.05863	-1.44	0.05	
11	7.56646	-21.92816	-1.36	0.12	
21	10.92933	-20.08592	-1.23	0.17	
31	13.19993	-17.6134	-1.07	0.20	
41	14.21725	-14.61385	-0.88	0.22	
51	13.95758	-11.20276	-0.67	0.21	
61	12.53449	-7.499118	-0.44	0.19	
71	10.18299	-3.618792	-0.21	0.15	
81	7.23	0.329008	0.02	0.11	
91	4.054422	4.242376	0.25	0.06	
101	1.04175	8.025158	0.48	0.02	
111	-1.461566	11.58457	0.69	-0.02	
121	-3.188568	14.8294	0.89	-0.05	
131	-3.982329	17.67003	1.08	-0.06	
141	-3.813017	20.02082	1.23	-0.06	
151	-2.779525	21.80466	1.35	-0.04	
161	-1.095526	22.95897	1.43	-0.02	
171	0.93833	23.44162	1.46	0.02	
181	2.972753	23.23551	1.45	0.05	
191	4.654073	22.35057	1.39	0.07	
201	5.669143	20.8227	1.28	0.09	
211	5.785522	18.70976	1.14	0.09	
221	4.882097	16.08566	0.97	0.07	
231	2.96648	13.03388	0.78	0.04	
241	0.177018	9.641848	0.57	0.00	
251	-3.23088	5.997384	0.35	-0.05	
261	-6.912601	2.187791	0.13	-0.10	
271	-10.47313	-1.698673	-0.10	-0.15	
281	-13.51231	-5.569878	-0.33	-0.20	
291	-15.67131	-9.326895	-0.55	-0.23	
301	-16.67476	-12.86258	-0.77	-0.25	
311	-16.36375	-16.06288	-0.97	-0.25	
321	-14.7157	-18.81141	-1.15	-0.23	
331	-11.84872	-20.99699	-1.30	-0.19	
341	-8.010019	-22.52308	-1.40	-0.13	
351	-3.549506	-23.31733	-1.45	-0.06	
361	1.1183	-23.33953	-1.46	0.02	

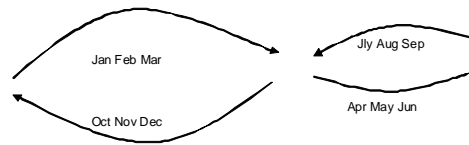
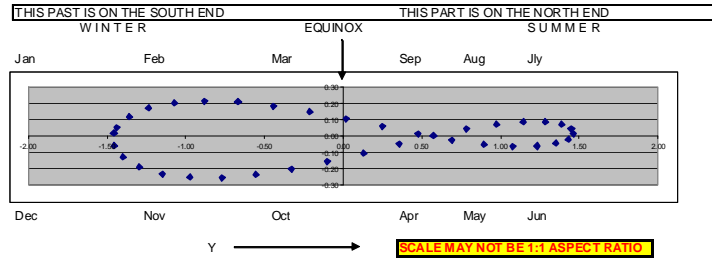

And a DeltaCAD macro is in the Analemma folder:- gnomonDialplateAnalemma.bas

Scaling is important if you use DeltaCAD, and aspect ratio as well as scaling if you use Excel or Open Office.

For DeltaCAD the  
 OPTIONS DRAWING SCALE must be 1  
 VIEW SC must be 1  
 FILE SET PRINT REGION PRINT SCALE must be 1

For spreadsheets, the data is useful more than the pictorial display since spreadsheets make no pretence at retaining aspect ratio when graphics are displayed.

For the clay armillary dial in question, the radius from gnomon style to the semi circular dial plate was:- **3.375** inches, and the spreadsheet has the X,Y pairs shown below:-

-1.44	0.05
-1.36	0.12
-1.23	0.17
-1.07	0.20
-0.88	0.22
-0.67	0.21
-0.44	0.19
-0.21	0.15
0.02	0.11
0.25	0.06
0.48	0.02
0.69	-0.02
0.89	-0.05
1.08	-0.06
1.23	-0.06
1.35	-0.04
1.43	-0.02
1.46	0.02
1.45	0.05
1.39	0.07
1.28	0.09
1.14	0.09
0.97	0.07
0.78	0.04
0.57	0.00
0.35	-0.05
0.13	-0.10
-0.10	-0.15
-0.33	-0.20
-0.55	-0.23
-0.77	-0.25
-0.97	-0.25
-1.15	-0.23
-1.30	-0.19
-1.40	-0.13
-1.45	-0.06
-1.46	0.02

Excel or Open office



DeltaCAD

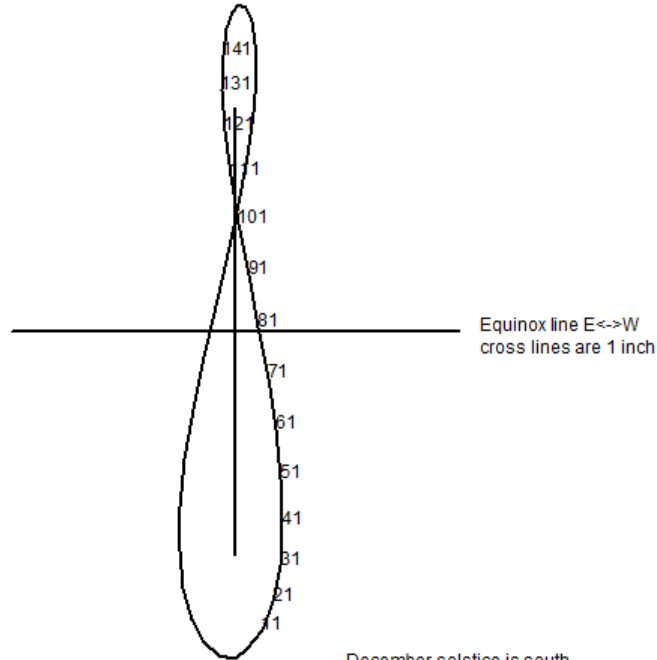

December solstice is south.  
Gnomon linear height in inches: 03.4  
Solstice to solstice distance: 2.92659

if you choose to use graph paper, or in DeltaCAD with the scales (all DeltaCAD scales), before and after running the macro all set to 1, see above.

After printing the DeltaCAD analemma gnomon, verify the north and south Y distance and compare it to the Excel range. For a gnomon style linear height of 3.375, the range is from -1.44 to +1.46, totaling =2.90 inches.

**NOTE:** as discussed earlier, a 2d rotatable analemma on the style is more accurate than a 3d bobbin analemma and requires no averaging of EOTs for a given sun's declination.

## ARMILLARY DIAL ~ analemma on the dial plate

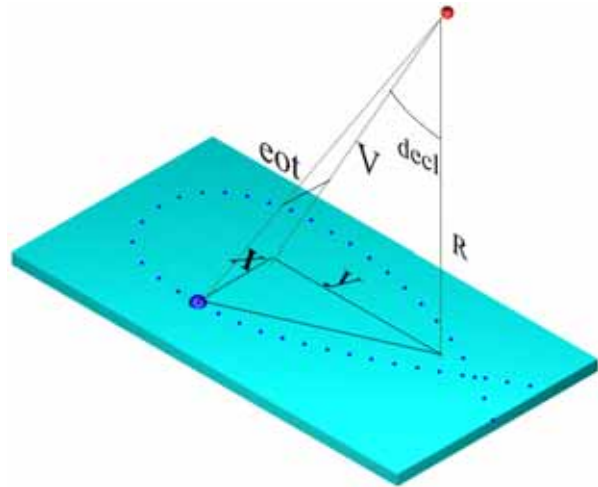

As with the bobbin (3d shaped gnomon) or 2d rotatable analemma, all on the gnomon style, the formula for the analemma on the dial plate turns out to be the same.

$$eot = 7.5 * \text{Sin}(\text{RAD}(jd-5)) - 10.2 * \text{Sin}(\text{RAD}(1.93 * (jd-80))) + 0.5 * \text{Sin}(\text{RAD}(1.5 * (jd-62)))$$

$$decl = 23.45 * \text{Sin}(\text{rad}(0.9678 * (jd-80)))$$

$$y = r * \text{Tan}(\text{rad}(decl))$$

$$V = r / \text{Cos}(\text{rad}(decl))$$

$$x = V * \text{Tan}(\text{rad}(eot/4))$$

$$= r * \text{Tan}(\text{rad}(eot/4)) / \text{Cos}(\text{rad}(decl))$$

Actually, almost the same. Whereas the larger EOT swing is to the south on an analemma built in to the gnomon, it is to the north when the analemma is on the dial plate itself. This is shown pictorially below. Also, not only is the analemma rotated about the east west axis as mentioned above, the picture on the right also shows that it must be rotated about the north south axis as well.

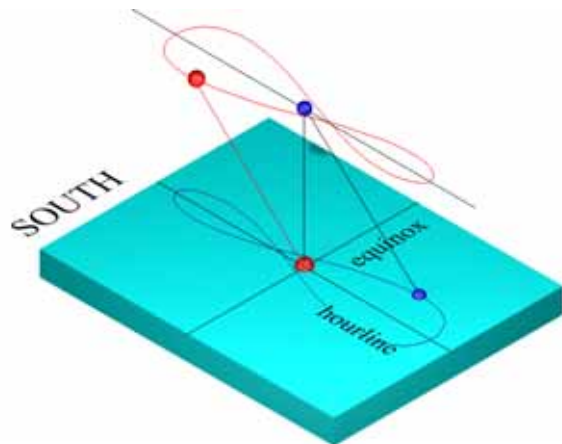

That rotation about the east west axis is critical because the end of the year EOT swing is some 16 minutes whereas the mid year swing is about half that, there is no symmetry.

Most 3d analemma gnomons assume there is symmetry of the + and - swings, but even that is not true. The end of year swing is 14.15 to -16.29, a difference of some two minutes, the mid year swing is 6.32 to -3.40, a difference of almost three minutes. The lobe location relative to south is valid for both hemispheres, that is why the term end of year and mid year were used, not summer and winter.

EOT		2009		mm.ss	
end of year		mid year			
MAJOR PEAKS		MINOR PEAKS			
MAX	MIN	MAX	MIN		
14.15	-16.29	6.32	-3.40		

The spreadsheet for the armillary gnomon: gnomonDialplateAnalemma.xls

can be used for the dial plate analemma provided the diagram is rotated both east to west and north to south.

The DeltaCAD program provides a second option because the end result is printed, thus it does those two rotations, and the comment about what part of the analemma lobe is south is also changed.

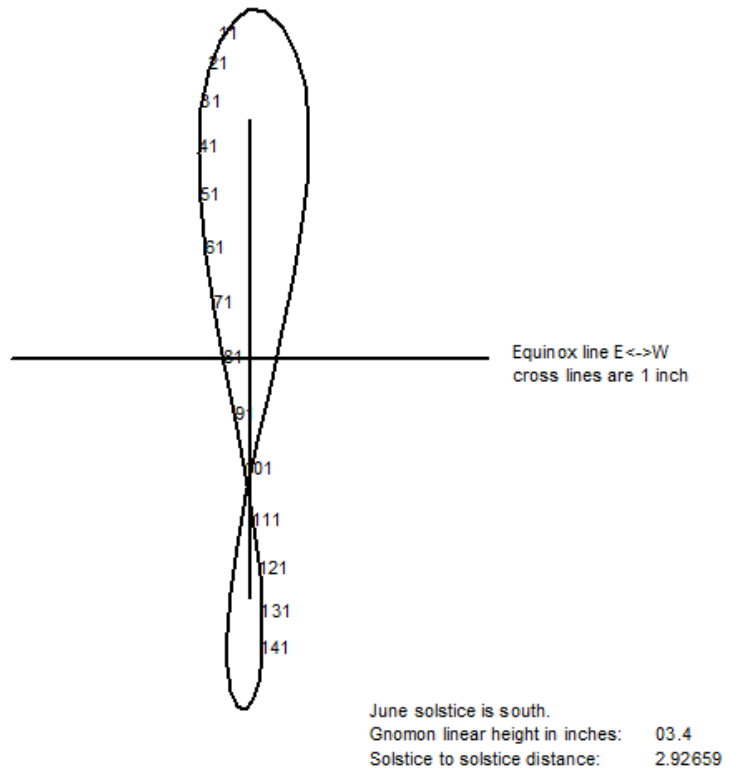



## EQUATORIAL DIAL ~ analemma on the gnomon style

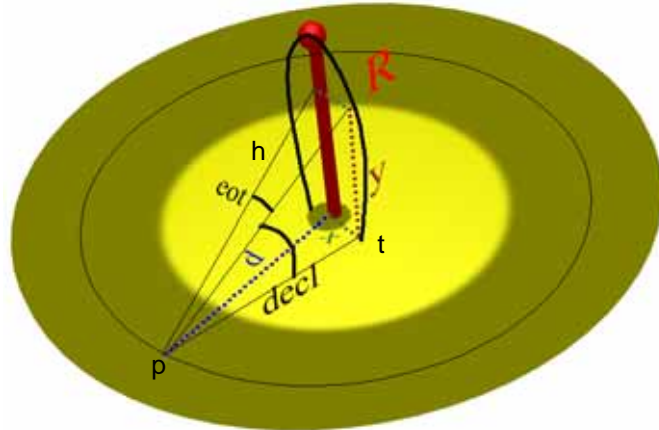

In this case, "d" is a fixed radius from the base of the gnomon rod, and falls on an hour line or some other time division that will be corrected by the gnomon. As usual, we need X and Y, and we also have the EOT and Declination. Assuming that the distance from "p" to the base of the gnomon, known as "x" is substantially the same as from "p" to point "t", which is not correct, but is almost the same, then:-

$$\tan(\text{decl}) = y / d$$

thus  $y = d * \tan(\text{decl})$

and assuming that EOT as shown is the same angle on the slope, as it would be between line "d" and the line "pt", which is not correct, but is almost the same, then:-

$$\tan(\text{eot}) = x / d$$

thus  $x = d * \tan(\text{eot})$

and again, these are assumptions that are close but not perfect. The rule of a 2d rotatable analemma on the gnomon still applies, it is more accurate and easier to make than a 3d bobbin.

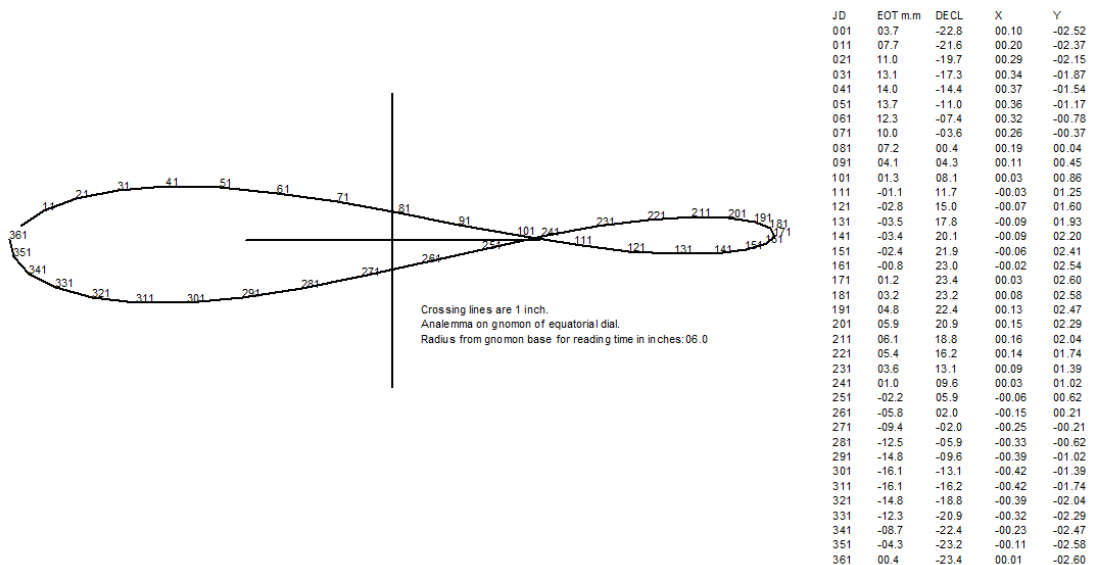

## EQUATORIAL DIAL ~ analemma on the dial plate

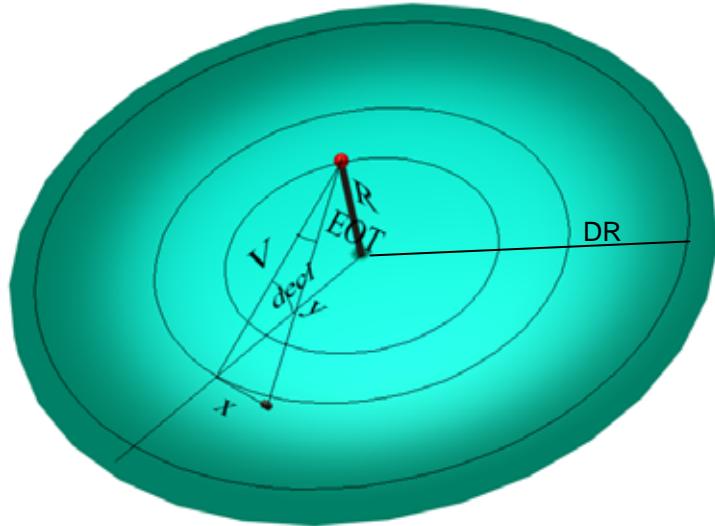

For a point on top of the gnomon, the nodus, a shadow will be drawn whose tip is based on the sun's declination, and whose displacement from a given hour line will be based on the equation of time, EOT. If the linear height of the gnomon rod is "R" inches then the following applies.

$$\begin{aligned} \tan(\text{decl}) &= R / y \\ \text{thus } y &= R / \tan(\text{decl}) \\ \text{and } \sin(\text{decl}) &= R / V \\ \text{thus } V &= R / \sin(\text{decl}) \\ \text{and } \tan(\text{EOTm}/4) &= x / V \\ \text{thus } x &= V * \tan(\text{EOTm}/4) \\ &= \tan(\text{EOTm}/4) * R / \sin(\text{decl}) \end{aligned}$$

and the summer surface uses JD (Julian Days) from March 21 through September 21 in the northern hemisphere

i.e. 80 through 265

and the winter surface uses 266 through 365, and 1 through 79 in the northern hemisphere.

However, at the equinoxes, the shadow tip is at an infinite point, thus a more practical range is perhaps when the declination is say 10 degrees.

winter	Oct 20 – Feb 23	JD	293-365	1-54
summer	Apr 17 – August 28	JD	107-240	

The best solution in fact would be where the value of Y is less than equal the radius of the dial plate, DR.

For the mid year analemma, DeltaCAD produces:-

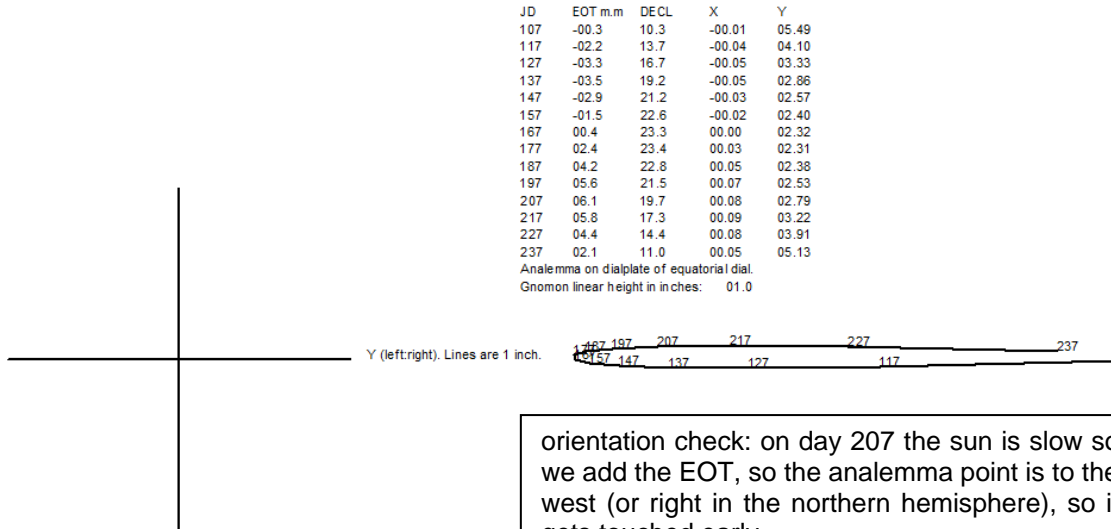

orientation check: on day 207 the sun is slow so we add the EOT, so the analemma point is to the west (or right in the northern hemisphere), so it gets touched early.

For the end and start of year DeltaCAD produces:-

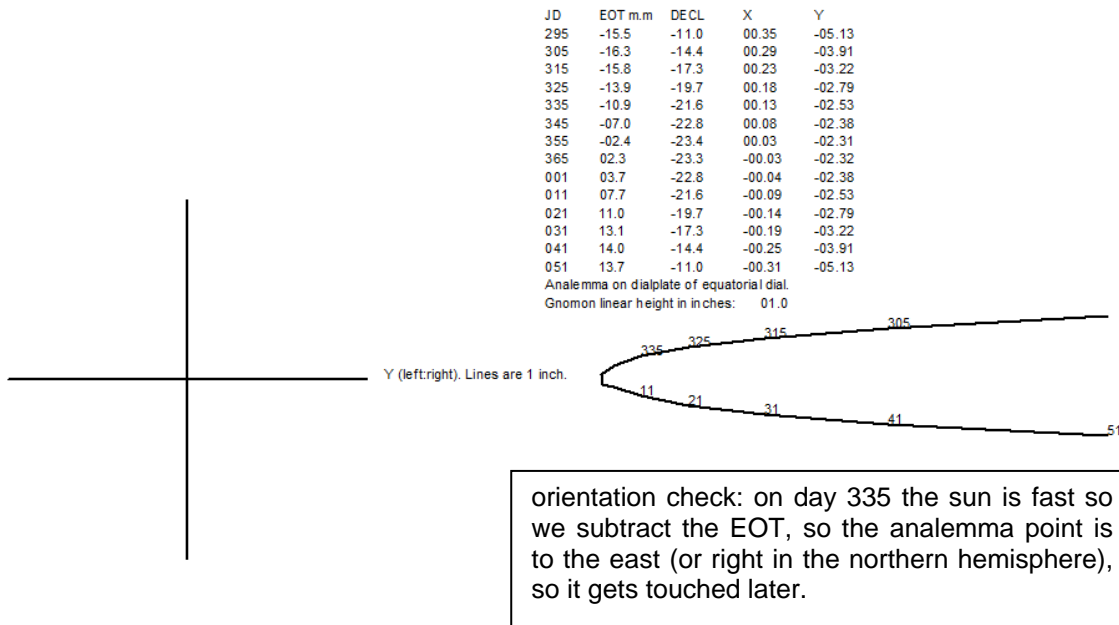

orientation check: on day 335 the sun is fast so we subtract the EOT, so the analemma point is to the east (or right in the northern hemisphere), so it gets touched later.

NOTE: Northern hemisphere: mid year (summer) is facing sky, end year (winter) faces ground.

NOTE: Southern hemisphere: mid year (winter) is facing ground, end year (summer) faces sky.

NOTE: If the sun is slow, i.e. the EOT is positive, the analemma point is to the west so it gets hit earlier. If the sun is fast, i.e. the EOT is negative, the analemma point is to the east so it gets hit later.

## HORIZONTAL AND VERTICAL DIALS – key notes

The armillary and equatorial dials were special cases in so far as the sun's declination was usable directly. The armillary dial formulae were symmetrical for an analemma on the gnomon or the dial plate, not so for the equatorial dial. For horizontal and vertical dials, a simple declination based formula is only usable at local apparent noon where the altitude of the sun is the co-latitude plus the declination. For hours other than local apparent noon, this is not true, and altitude and azimuth become the issue.

Hour lines are of course mean hour lines. What makes them match a clock is the longitude correction and the equation of time. Dial furniture can accommodate this information relieving the observer from this simple adjustment. The longitude correction is a fixed adjustment to the sun's hour angle, but the equation of time varies by the day.

The analemma curve, an approximate figure of eight, attempts to show the correct time for the latitude, longitude and date by where the nodus falls. These legal standard time curves approximate figures of eight, and as such are ambiguous for the most part. In other words, the same solar declination may have associated with it two different EOTs, this is because except for the solstices, two dates share the same declination.

The derivation of the analemma is simple. From the base of the nodus, a line is drawn at an angle and for a distance. Then for a selected time which the analemma figure of eight will represent, the shadow tip is calculated for the yearly cycle. That angle is the sun's azimuth at the dial's location for a desired time. And that distance is the nodus linear perpendicular height above the dial plate divided by the tangent of the sun's altitude. Of course, any time can be used. Complications arise for latitudes below 23.5 as the altitude "goes over the top", and for some hours when the azimuth moves from north to south.

The polar coordinate system is simple, it is the azimuth for direction, and the nodus linear height divided by the tangent of the altitude, for the appointed time. And that time is the legal time modified by the longitude correction (fixed) and the EOT (varies by the day).

Polar coordinates are simple, but suffer from the need for accurate angles, thus, x,y coordinates may be more accurate in practical drafting. Conversion from azimuth/distance to x,y cartesian coordinates is also simple, for some latitudes and times, some extra steps are needed because of altitudes passing through 90 degrees, or azimuths moving from north to south or vice versa..

$$\begin{aligned}x &= \text{polar distance} * \sin(\text{azimuth}) \\y &= \text{polar distance} * \cos(\text{azimuth})\end{aligned}$$

The altitude and azimuth are simple calculations, and their basic formulae are in the appendix. The illustrating-shadows.xls spreadsheet has these calculations programmed and all that is needed is a latitude, longitude, time and a gnomon linear height. For example, consider the following data:

FOR THIS LATITUDE:	32.75
ENTER A TIME FOR THE ANALEMMA DATA hh.hh:	12.00
ENTER A GNOMON HEIGHT IN ANY UNITS:	100

The spreadsheet provides a summary table for about every ten days with both the polar coordinates (azimuth and distance) as well as the Cartesian coordinates (x and y distances from the base of the gnomon). Note that this is the gnomon base and not dial center. The spreadsheet is designed for latitudes between 0 and 60 approximately, and the noon hour plus or minus a few hours.

Assumed latitude (0-90)	32.75	→	12.8 LEGAL
Assumed longitude (0-180 + or -)	108.20		
Assumed time zone's reference longitude	105.00		
You can change the time → TIME FOR THE ANALEMMA DATA hh:hr		→	12.00 (8:00 9:00 10:00 11:00 12:00 13:00 14:00 15:00 16:00)
NODUS HEIGHT IN ANY UNITS: →		→	1

**CARTESIAN ANALEMMA COORDINATES -- HORIZONTAL DIAL**  
Cartesian coordinates (x and y distances from the base of the gnomon). Note that this is the gnomon base and not dial center.

Date	Julian	decl	eot	net mm	Alt	POLAR COORDINATES			FINAL CARTESIAN COORDINATES	
						DIST	Azi	x	y	
1/1	1	-23.1	3.1	15.9	34.06	1.48	4.42	-0.114	1.475	
1/10	10	-22.1	7.1	19.9	34.97	1.43	5.63	-0.140	1.423	
1/20	20	-20.3	10.7	23.5	36.65	1.34	6.87	-0.161	1.334	
2/1	32	-17.3	13.5	26.3	39.52	1.21	8.15	-0.172	1.200	
2/10	41	-14.6	14.3	27.1	42.20	1.10	8.86	-0.170	1.090	
2/20	51	-11.2	13.9	26.7	45.59	0.98	9.38	-0.160	0.967	
3/1	60	-7.9	12.2	25.0	48.94	0.87	9.45	-0.143	0.859	
3/10	69	-4.4	10.1	22.9	52.45	0.77	9.39	-0.125	0.758	
3/20	79	-0.5	7.2	20.0	56.46	0.66	9.07	-0.105	0.655	
4/1	91	4.2	3.6	16.4	61.24	0.55	8.52	-0.081	0.543	
4/10	100	7.7	1.1	13.9	64.70	0.47	8.08	-0.066	0.468	
4/20	110	11.2	-1.3	11.5	68.33	0.40	7.66	-0.053	0.394	
5/1	121	14.8	-3.0	9.8	71.94	0.33	7.66	-0.043	0.323	
5/10	130	17.4	-3.6	9.2	74.52	0.28	8.25	-0.040	0.274	
5/20	140	19.8	-3.4	9.4	76.89	0.23	9.79	-0.040	0.229	
6/1	152	21.9	-2.1	10.7	78.94	0.20	13.04	-0.044	0.190	
6/10	161	23.0	-0.4	12.4	79.83	0.18	16.39	-0.051	0.172	
6/20	171	23.4	1.7	14.5	80.16	0.17	19.84	-0.059	0.163	
7/1	182	23.2	4.0	16.8	79.74	0.18	22.20	-0.068	0.168	
7/10	191	22.4	5.5	18.3	78.84	0.20	22.41	-0.075	0.182	
7/20	201	20.8	6.4	19.2	77.33	0.22	20.89	-0.080	0.210	
8/1	213	18.2	6.3	19.1	74.85	0.27	17.61	-0.082	0.258	
8/10	222	15.8	5.2	18.0	72.56	0.31	14.59	-0.079	0.304	
8/20	232	12.7	3.2	16.0	69.63	0.37	11.27	-0.073	0.364	
9/1	244	8.6	-0.3	12.5	65.65	0.45	7.51	-0.059	0.449	
9/10	253	5.2	-3.3	9.5	62.41	0.52	5.11	-0.047	0.521	
9/20	263	1.4	-6.9	5.9	58.63	0.61	2.83	-0.030	0.609	
10/1	274	-2.9	-10.6	2.2	54.38	0.72	0.94	-0.012	0.716	
10/10	283	-6.3	-13.2	-0.4	50.92	0.81	-0.16	0.002	0.812	
10/20	293	-10.1	-15.4	-2.6	47.19	0.93	-0.94	0.015	0.926	
11/1	304	-13.9	-16.5	-3.7	43.38	1.06	-1.24	0.023	1.058	
11/10	314	-16.9	-16.0	-3.2	40.30	1.18	-1.01	0.021	1.179	
11/20	324	-19.5	-14.1	-1.3	37.72	1.29	-0.39	0.009	1.293	
12/1	335	-21.7	-10.6	2.2	35.56	1.40	0.63	-0.015	1.399	
12/10	344	-22.8	-6.8	6.0	34.39	1.46	1.68	-0.043	1.460	
12/20	354	-23.4	-1.9	10.90	33.78	1.49	3.01	-0.078	1.493	

For vertical dial, reverse d, long and use co-latitude  
For vertical decliner, SH as latitude, but hours are more invd'ed.

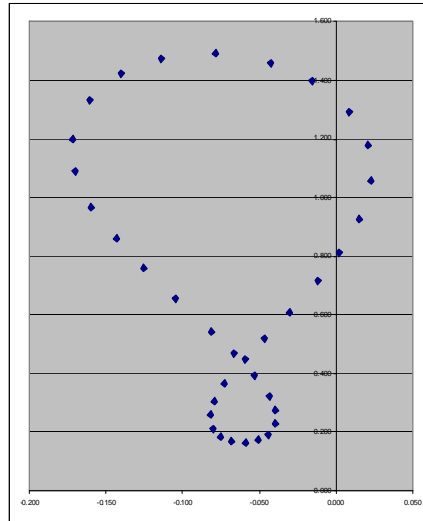

**NOTE** For most cases, the final data is the most frequently usable. In some cases, the final data here may be less usable, the test is the graph above. If the graph above looks inappropriate, whereas the raw data graph to the right looks appropriate, then in that case use the raw data information.

**NOTE** These figures are in close agreement with other systems. However, each system uses different EOT formulae as well as declination formulae, so this data may be slightly different from other programs.

**NOTE** design latitude is from 0 degrees to 66 degrees

The graph to the right is the graph of the x and y coordinates of the point that the nodus tip will impact a horizontal dial for a given legal time at the dial's latitude and longitude.

While Italian hour lines convey useful information, the analemma figure of eight tends to clutter the dial, and still requires the ambiguous month for it to work correctly, so it does not save much observer time for the added cluttering of the dial plate. Some ingenious diallists have made gnomons whose shape is a double pear drop or 3d figure of eight where the approximation is that the figure of eight is symmetrical, which it is not. And other ingenious variations on that theme exist. A number of dials use these figures of eight, however the majority do not, either from ignorance, or from the provision of an EOT and longitude correction chart. Most of the author's dials are longitude corrected so only an EOT chart is needed.

**Horizontal Dial – analemma on dial plate – DeltaCAD program**

Program: gnomonDialplateAnalemma.bas

which is also choice 8 of the standard: MAIN-h-dials.bas

can display a complete horizontal dial with calendar curves and the analemma.

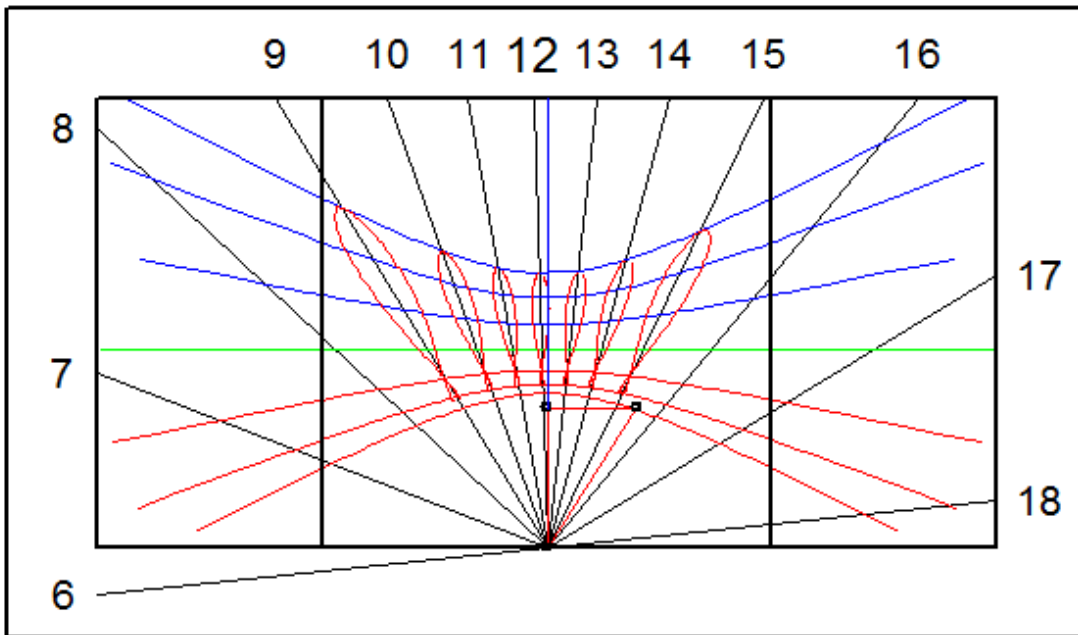

**h-dial and calendar using gnomon linear height**

Lat: 32.8 d.Long: 03.2

6	7	8	9	10	11	12	13	14	15	16	17	18
84.1	-68.9	-47.0	-31.2	-19.5	-10.1	-0.17	06.4	15.3	25.8	39.6	58.7	84.1

**Hours below horizontal use the 90 reference line below horizontal.**

### Vertical Dial – analemma on dial plate – DeltaCAD program

Program: gnomonDialplateAnalemma.bas

which is also choice 7 of the standard: MAIN-v-dials.bas

can display a complete vertical dial with calendar curves and the analemma.

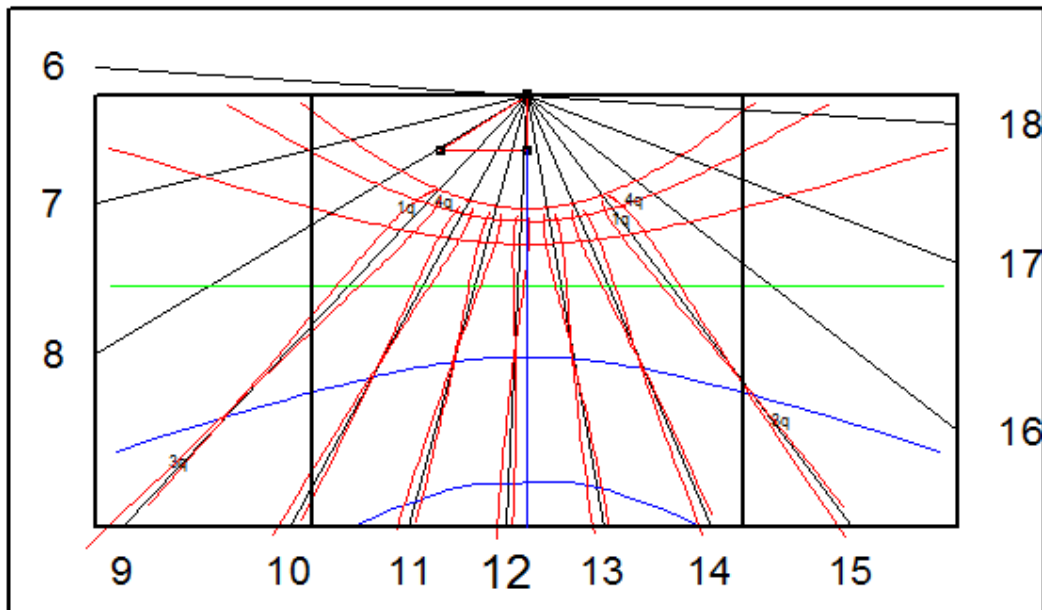

v-dial and calendar using gnomon linear height

Lat: 57.3 d.Long: -03.2

18	17	16	15	14	13	12	11	10	9	8	7	6
-86.2	-68.6	-52.1	-36.9	-23.0	-10.0	02.7	15.5	28.8	43.2	59.0	76.1	-86.2

Hours below horizontal use the 90 reference line below horizontal.

### Vertical Declining Dial – analemma on dial plate

For vertical decliners, the normal dial can be created as a decliner, then a horizontal dial with a latitude equal to the v-dec dial's SD can be slid over the vertical decliner's dial plate such that 12 noon local apparent time on the pseudo horizontal dial plate matches the SD on the real vertical decliner.

The process above is discussed in *Illustrating Time's Shadow*, as well as in a couple of supplementary documents on the web site. For the analemma however, a problem arises.

The hour lines on the real vertical decliner, and the hour lines on the pseudo horizontal surrogate dial will normally never match. And thus nor will the analemma figures.

At this point a philosophical point comes into play.

Either you have one master analemma, and put that on the noon local apparent time of the pseudo surrogate horizontal dial, which results in a single analemma on the SD line of the real vertical decliner, or, generate pure analemmas for the final dial plate.

The first option simplifies the process, and reduces clutter on the dial plate.

The second option requires adjusting the hour lines on the surrogate plate, and this is done by using a longitude adjustment. And that adjustment has nothing to do with the real vertical decliner's design longitude. It is a value that will simulate a longitude that will enable the surrogate dial's hours lines, and thus analemmas, to match the real dial.

This magical longitude difference is called "DL" or difference in longitude, and is derived from a simple formula from the vertical decliner.

Choice 3 (vertical decliner) of the vertical dial DeltaCAD macro provides that DL. So do the master spreadsheets:

illustrating-shadows.xls                      and                      illustrating-shadows.ods

and the formula is very simple:-

$$DL = \text{Atn}(\tan(\text{dec}) / \sin(\text{lat})) + \text{v-dec longitude} - \text{legal meridian longitude}$$

Using this DL as the longitude but reduce by 15 degrees if it was larger than 15, until the result is 15 degrees or less. Also, use a legal meridian of 0 in the horizontal dial plate generator. The resulting hours will produce hours lines that match the real vertical decliner, and thus the analemma figures will also align.

**KEY POINT:** One analemma anywhere on a dial is equally as useful as well aligned analemmas because even with a perfect analemma portrayal, they are only directly usable for the time they were designed for.

**MORAL:** Only place one analemma on a dial plate, it is uncluttered and still gets the message across.

Or place a chart or table on the dial. Keep it simple.

However, for the perfectionist, the next page shows a full set of analemma for a vertical decliner.



For example, a vertical decliner is needed for latitude 32.75, facing SW -45 degrees.

Choice 3 of the vertical dial DeltaCAD macro creates the vertical decliner.

The DL (difference in longitude) is -64.8 (raw -61.6 degrees minus the v-dec dial's longitude from the meridian). Minus the v-dec's longitude difference because signs reverse when going from a v-dial to an h-dial design. this will be surrogate horizontal dial's longitude difference from the legal meridian of 0 .

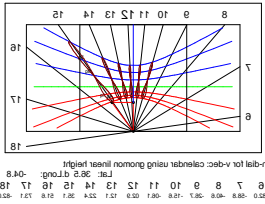
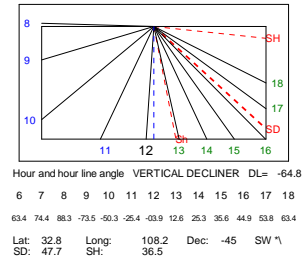

And the SH (style height) is 36.5 degrees which is the latitude for the surrogate horizontal dial with calendar data.

And note that the SD is where the surrogate horizontal dial's true noon (not longitude corrected) will be positioned.

If only calendar or declination curves were needed, then a horizontal dial for a latitude equal to 36.5 would be used, as described in chapter 22.

However since analemma are required, the horizontal dial with analemmas feature of the analemma DeltaCAD macro is used, but there is a problem. The analemma for a horizontal dial needs to be (1) rotated top to bottom and (2) left to right because the (1) solstice curves for the two types are opposite, and (2) the hour lines are sequenced in opposite directions. Choice 0 of the DeltaCAD analemma macro derives the correct DL and also invokes the surrogate horizontal dial choice while triggering the analemma reversal.

The h-dial choice is provided with a latitude of 36.5, (SH from vertical decliner) and a longitude of -64.8 (DL from the vertical decliner) with a legal reference meridian of 0. Longitude 64.8 presents problems for the program since the span exceeds normal time zone references, so reducing that by 15 until the result is 15 or less works better. So -4.8 is the result.

And as a cross check, using for example the vertical decliner's 1400 hour angle of 25.3, from the SD of 47.7, the result is 22.4. The 1400 hour is 3 hour lines from SD, and looking at its matching horizontal dial's 3 hours from true local uncorrected noon, coincidentally 1400, it is 22.5 degrees (rounding happens). Thus this is the correct surrogate dial for a vertical decliner and can be slid along the decliner's SD line as discussed in chapter 23. The analemma macros also automates this for you if you so choose.

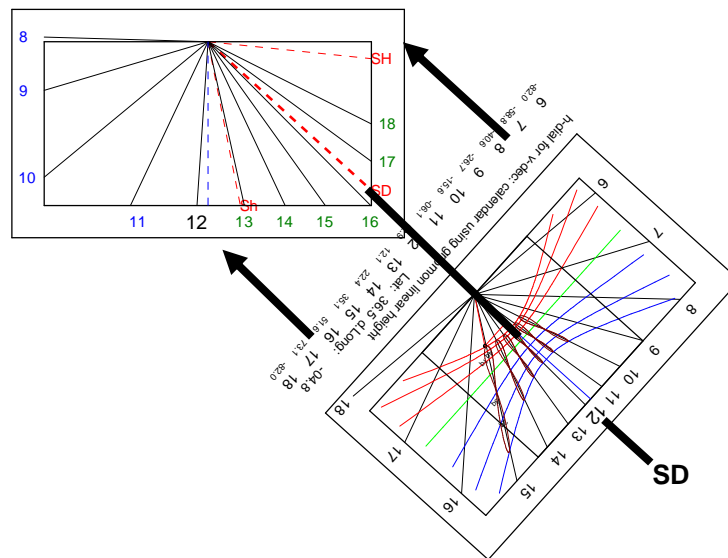

### Polar Dial – analemma on dial plate

The polar dial can use a different formula for drawing the analemma. The method used here still derives the equation of time (EOT) and declination, however in this dial's case the altitude and azimuth are not used.

The logic is simply to locate the hour line, longitude corrected, and this is:-

$$\text{dial center to hour line} = \text{sh} * \tan(\text{lha from noon})$$

And then for each day of the year, we derive the declination and EOT. Then we vary the "X" coordinate by the EOT, and the "Y" coordinate is derived using:-

$$\begin{array}{l} \text{distance up an hour line} \\ \text{longitude and EOT} \\ \text{corrected} \\ \text{to matching declination point} \end{array} = \text{sh} * \tan(\text{declination}) / \cos(\text{time})$$

In this fashion, the altitude and azimuth are not required, and the figure of eight distortion due to "X" increasing with distance, are also managed.

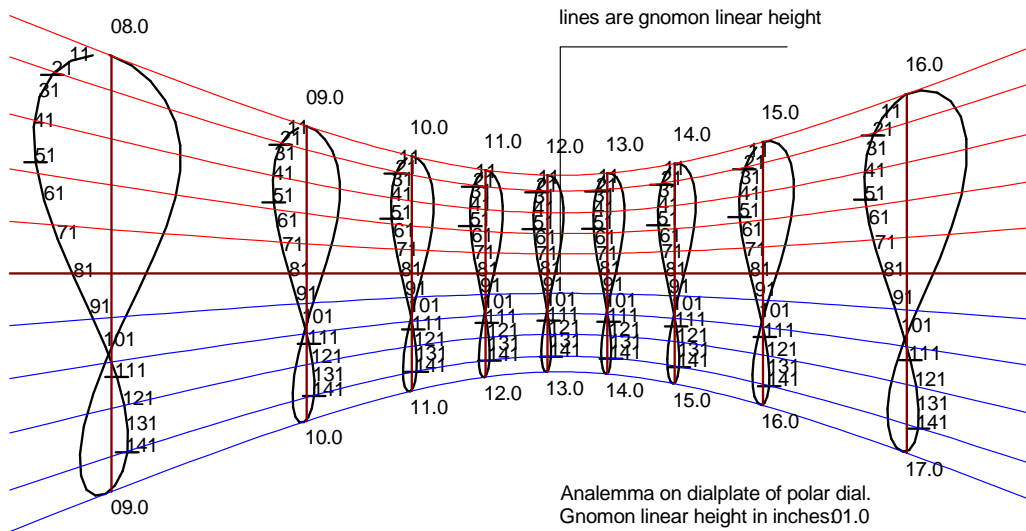

This same display is usable directly as a meridian dial, namely a vertical dial facing true east or true west.